

TECHNICAL
SPECIFICATIONS

grandeur

PIANCA

WING DOOR

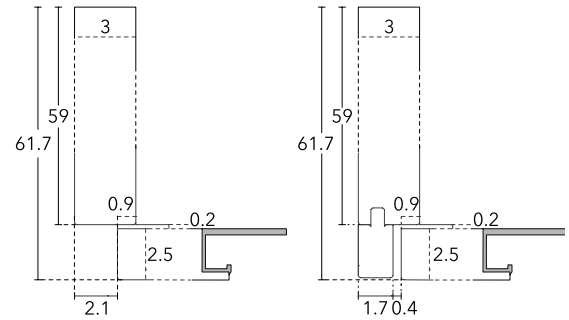
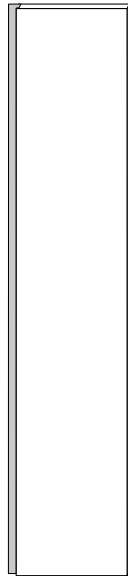

Deep wing frameless side

Deep wing side with frame

DOOR DIMENSION

W 50 | H 238.5- 257.7- 289.7* cm

W 60 | H 238.5- 257.7- 289.7* cm

W 70 | H 238.5- 257.7- 289.7* cm

*H not available for glass and mirror finishes

CHARACTERISTICS

Doors made of 2.5 cm engineered wood panels or 1.9 cm LIGHT engineered wood panels covered with a 0.4 cm tempered glass or mirror panel.

Door interior with panels lacquered with the same finish as the outside, or Matt lacquered on request for glass and mirror door.

Finishes matt; matt Alaska (Horizontal grain); Matt and High gloss lacquered; Wood (wood veneer with vertical grain); Matt and glossy lacquered glass; silver and smokey mirror.

Vertical Handle, It can be disassembled, recessed in the door, Matt lacquered aluminum in all colors of the collection. Optional mechanical and electronic lock with standard handle.

PIANCA

WING DOOR MODULES D 60

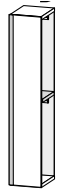

W 47.8 cm
W 57.8 cm
W 67.8 cm

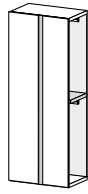

W 97.8 cm

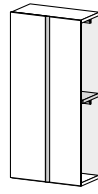

W 117.8 cm

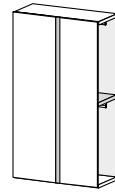

W 137.8 cm

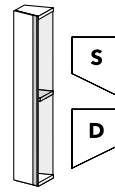

TERMINAL
W 46.1 cm

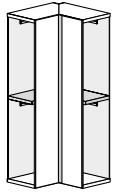

CORNER
W 110.7 cm

Height 238.5 | 257.7 | 289.7 cm available in custom size with additional charge

COMPOSITIONS



• 50 • 100 •
W 153.8 cm

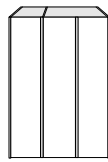

• 60 • 120 •
W 183.8 cm

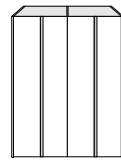

• 100 • 100 •
W 203.8 cm

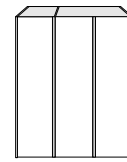

• 70 • 140 •
W 213.8 cm

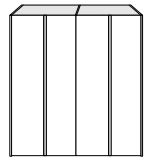

• 120 • 120 •
W 243.8 cm

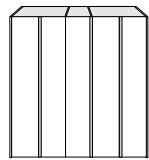

• 100 • 50 • 100 •
W 253.8 cm

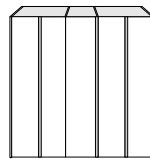

• 100 • 60 • 100 •
W 263.8 cm

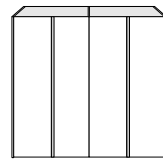

• 140 • 140 •
W 283.8 cm

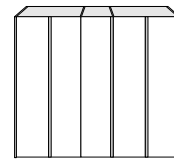

• 120 • 60 • 120 •
W 303.8 cm

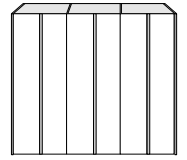

• 100 • 100 • 100 •
W 303.8 cm

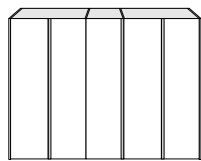

• 140 • 70 • 140 •
W 353.8 cm

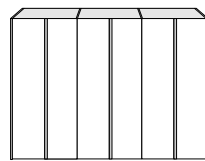

• 120 • 120 • 120 •
W 363.8 cm

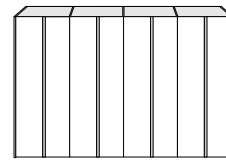

• 100 • 100 • 100 • 100 •
W 403.8 cm

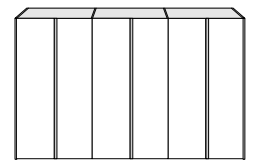

• 140 • 140 • 140 •
W 423.8 cm

PIANCA

MADE TO MEASURE SOLUTIONS

With Pianca you choose to enrich your wardrobe's uses and functionality: a vast array of uniquely modular additions such as: terminal elements, bridges, dressing closet, fillers. Just add the option to request tailor-made solutions for your structure to adapt and fit right into any space inside your home.*

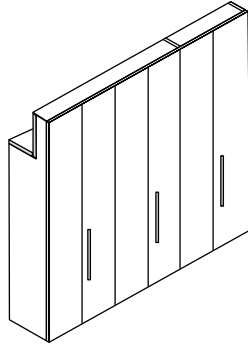

DEPTH REDUCTION

Possible reductions on wing, sliding, bridge solutions but not on flush sliding modules.

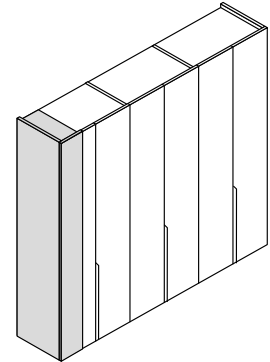

WIDTH REDUCTION

It is possible to reduce in width wing modules, sliding modules, bridge solutions and closets.

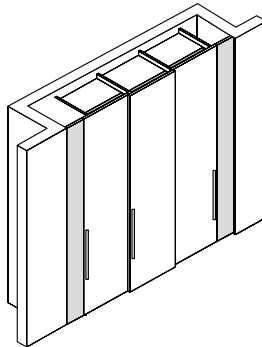

FILLERS

Available for wing and sliding modules, both for superior and lateral fillers. The fillers are available for fixing it flush with the door or with the side.

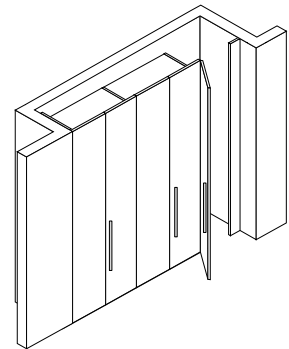

FILLER DOORS

Lateral filler with wing opening made-to-measure in width from 15 to 70 cm equipped with wall mounted stopper and 180° hinges. It is not possible to use the Y handle or the push pull opening.

* No customization is possible for Cornice and Link doors with aluminium frame, Print, Crea, Riflesso, Vela, Vitrum and Window doors; flush-sliding; wing door terminal modules; dressing closet. Drawers as well as glass, metal and pull-out accessories cannot be custom sized.

PIANCA

BRIDGE ELEMENTS

The bridge elements can be combined with wing door modules or sliding door modules internal door only. The doors of a bridge element have the same thickness as the wardrobe's wing doors. As a consequence they do not need any handle; the handle function is performed by a protrusion on the lower side of the door. For this reason Plana doors can be used with the Tratto and Nastro wood doors, whereas the Cornice doors can be used also with the Link doors.

BRIDGE MODULES

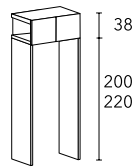

W 97.8 cm

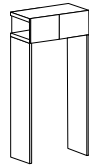

W 117.8 cm

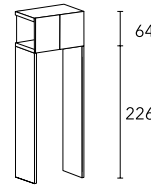

W 97.8 cm

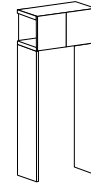

W 117.8 cm

Height 238.5 | 257.7 | 289.7 cm available in custom size with additional charge

BRIDGE MODULES

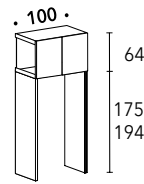

W 97.8 cm*

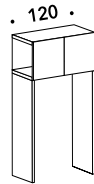

W 117.8 cm*

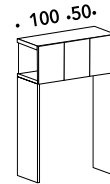

W 147.8 cm*

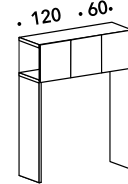

W 177.8 cm*

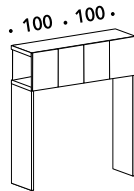

W 197.8 cm*

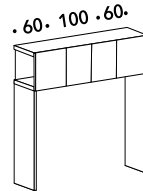

W 217.8 cm*

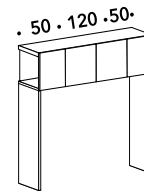

W 217.8 cm*

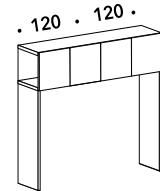

W 237.8 cm*

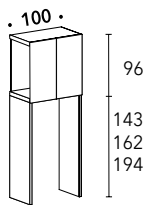

W 97.8 cm

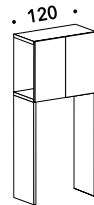

W 117.8 cm

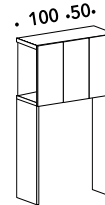

W 147.8 cm

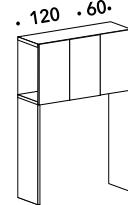

W 177.8 cm

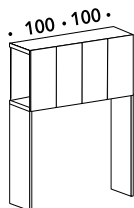

W 197.8 cm

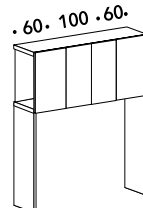

W 217.8 cm

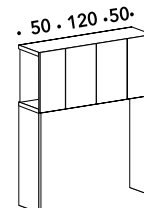

W 217.8 cm

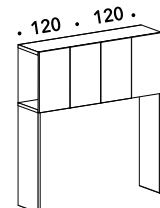

W 237.8 cm

* H 289.7 not available

Height 238.5 | 257.7 | 289.7 cm available in custom size with additional charge

PIANCA

INTERIORS

Tidy wardrobe interiors are guaranteed by an extensive array of internal fittings, functional solutions with painstaking care for details. The shelves and cubbies stand out for their thickness, while the drawer units can be made with wooden or glass fronts.

The choice of fittings is available in the range of lacquered and wood finishes and three finishes for the wardrobe structure: Bianco talco, Perlage terra, Perlage conchiglia and Borgogna.

Interior configurations

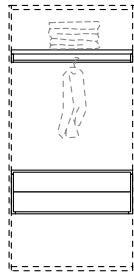

AM PROPOSE:
1 hanging rod
1 wooden shelf
1 hanging drawer unit

DIMENSIONS
W 97.8 | 117.8 | 137.8 | 147.8

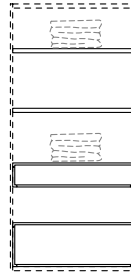

AN PROPOSE:
2 wooden shelves
1 hanging drawer unit
1 floor-sitting drawer unit

DIMENSIONS
W 97.8 | 117.8 | 137.8 | 147.8

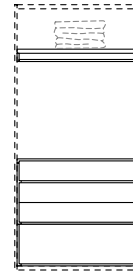

AP PROPOSE:
1 hanging rod
1 wooden shelf
1 floor-sitting drawer unit

DIMENSIONS
W 97.8 | 117.8 | 137.8 | 147.8

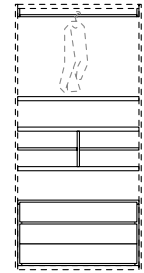

AQ PROPOSE:
1 hanging rod
1 wooden shelf
1 floor-sitting drawer unit
1 wooden cubby

DIMENSIONS
W 97.8 | 117.8



AE PROPOSE:
2 hanging rods
4 wooden shelves
1 internal partition

DIMENSIONS
W 97.8 | 117.8 | 137.8 | 147.8 cm

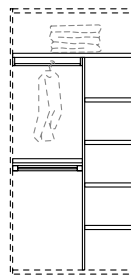

AL PROPOSE:
1 hanging rod
6 wooden shelves
1 internal partition
1 pull-out trouser rack

DIMENSIONS
W 117.8 | 137.8 | 147.8 cm

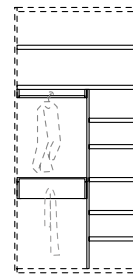

AC PROPOSE:
1 hanging rod
7 wooden shelves
1 hanging drawer unit
1 pull-out trouser
1 internal partition

DIMENSIONS
W 117.8 | 137.8 | 147.8 cm

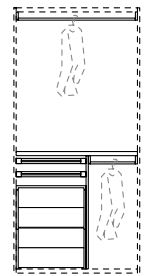

AD PROPOSE:
2 hanging rods
1 wooden shelf
2 pull-out wooden shelves
1 floor sitting drawer unit
1 internal partition

DIMENSIONS
W 117.8 | 137.8 | 147.8 cm

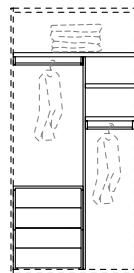

AK PROPOSE:
2 hanging rods
3 wooden shelves
1 floor sitting drawer unit
1 internal partition

DIMENSIONS
W 97.8 | 117.8 | 137.8 | 147.8

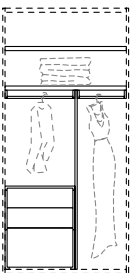

AA PROPOSE:
2 hanging rods
2 wooden shelves
1 floor sitting drawer unit
1 internal partition

DIMENSIONS
W 97.8 | 117.8 | 137.8 | 147.8

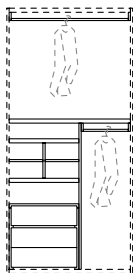

AF PROPOSE:
2 hanging rods
1 wooden shelves
1 floor sitting drawer unit
1 wooden cubby
1 internal partition

DIMENSIONS
W 117.8 | 137.8 | 147.8 cm

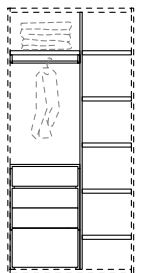

AH PROPOSE:
1 hanging rod
6 wooden shelves
1 floor sitting drawer unit
1 internal partition

DIMENSIONS
W 117.8 | 137.8 | 147.8 cm

PIANCA

INTERNAL ACCESSORIES



PULL-OUT SHELF
In aluminium with wooden or glass shelf and front



PULL-OUT
aluminium tray with front



PULL-OUT HAMPER
With aluminium support and front



PULL-OUT BELT/TIE RACK
To be applied on the closet sides



BASIC PULL-OUT TROUSER RACK



PULL-OUT ALLUMINIUM TROUSER RACK
Trouser rack with front



PULL-OUT DOUBLE SHOE RACK



PULL-OUT SHOE RACK



FIXED SHOE RACK



PULL-DOWN ROD
Manual or electrical



PULL-OUT ADJUSTABLE MIRROR
For unit with sliding doors or open closets



SENSOR-ACTIVATED
Recessed led lights for tops and shelves

PIANCA

ACCESSORIES

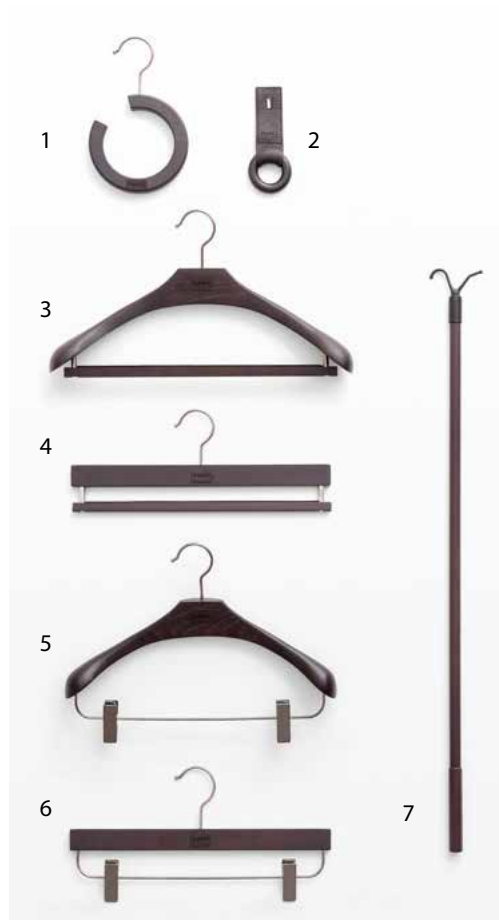

1. Scarves shawls and handbags ring hanger
2. Ties and belts ring hanger
3. Jacket + trouser hanger
4. Trousers hanger
5. Jacket + skirt hanger
6. Skirt hanger
7. Hooked rod

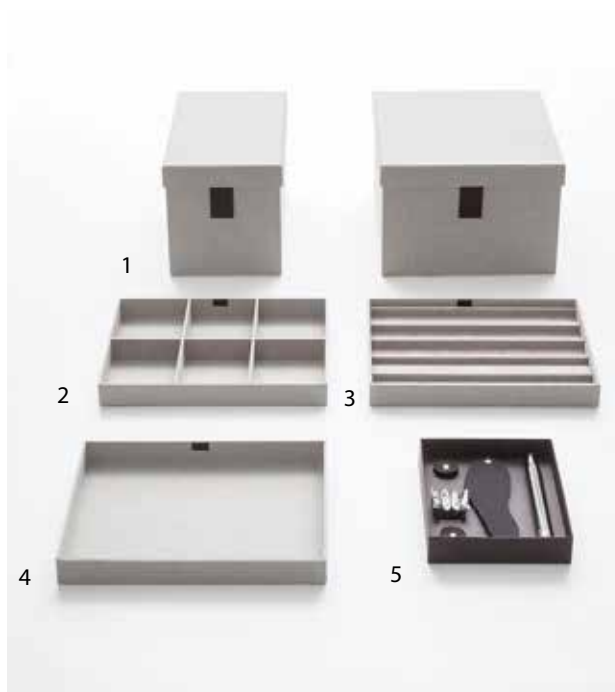

1. Boxed covered with light grey fabric
2. Tray with light grey fabric lining and cubbies for ties and belts in microfiber
3. Tray with light grey fabric lining and jewelry organizer in microfiber
4. Tray with light grey fabric lining
5. Scents and diffusers set